

USERS MANUAL

Intelligent Digital AC/DC Clamp Meter

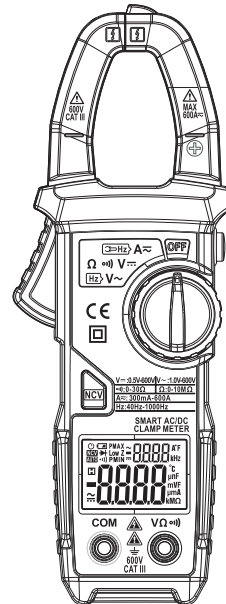

EMC&LVD

Designed and Conforms to
IEC61010-1
CAT.III 600V



Designed and Conforms to
IEC61010-1
CAT.III 600V

Y01-04-0141 A0



Before using the instrument, please read this manual carefully, and save it well for future using.

size:125x85mm

Table of Contents

1. Safety Information	1
1.1 Preparations	1
1.2 Marks	2
1.3 Maintenance	2
2. Descriptions.....	3
2.1 Part Name	3
2.2 Instructions to rotary switch and key as well as input socket	4
2.3 LCD Display Unit.....	4
3. Specifications.....	5
3.1 Overview	5
3.2 Technical Index.....	6
4. Operation Guide	9
4.1 Readings Hold	9
4.2 BackLight.....	9
4.3 Auto Power Off	9
4.4 Measurement Preparations	10
4.5 Non-contact Voltage Detection (NCV).....	10
4.6 AC/DC Current Measurement.....	12
4.7 DC Voltage Measurement	12
4.8 AC Voltage Measurement	13
4.9 Resistance Measurement.....	14

4.10 Measure AC current and AC voltage at the same time	15
4.11 Measure AC current and DC voltage at the same time	16
4.12 Measure AC current and resistance at the same time	16
5. Maintenance	17
5.1 Replace Battery	17
5.2 Replace Pen-shaped Meter.....	18
6. Accessories.....	18

1. Safety Information

Warnings



Special attention shall be paid when using the meter, improper use might cause an electric shock or damage the meter. General safety procedures shall be followed during the use and safety measures regulated by the instruction manual shall be completely respected.

To fully make use of the functions of the meter and ensure safe operation, please carefully read and follow the use method of this manual.

The meter meets IEC-61010-1, IEC-61010-2-030, IEC-61010-2-032) Safety Requirements for Electronic Measuring Instruments, of the secondary pollution, over-voltage standard is CATIII 600V.





Please follow the safe operation guidance and ensure to use the meter in safe.

1.1 Preparations

- ⇒ When use the meter, users must comply with the standard safety rules:
 - General protection against electric shock
 - Prevent misuse of the meter
- ⇒ After received the meter, check if it has been damaged during the delivery.
- ⇒ After been kept and delivered in shoddy conditions, check and confirm if the meter is damaged or not.
- ⇒ The pen-shape meter must be in good condition.

- ⇒ Before use, check the pen-shape meter see if any damage to the insulation, if the metal wire of the cable is bare.

1.2 Marks

	Note (important security information, see the Instruction Manual)
	It can be used on hazardous live conductors.
	Double insulation protection (Category II)
CAT III	follows the over-voltage (Setup) level III of IEC-61010-1 standard and pollution degree 2 means the impulse withstand voltage level of protection provided.
	In line with the European Union (EU) Standard
	Grounding

1.3 Maintenance

- ⇒ Please do not attempt to open the bottom case to adjust or repair the meter, such operation could only be performed by technicians fully aware of the meter and the risk of electric shock.
- ⇒ Before opening the meter case or battery cover at the end, the pen-shape meter should be removed from the circuit being measured.
- ⇒ To avoid electric shock that might be caused by erroneous readings, when the meter displays “+” symbol, the battery should be replaced immediately.
- ⇒ Use a damp cloth and mild detergent to clean the meter, do not use abrasive cleaning agents or solvents.

- ⇒ Power supply of the meter should be turned off when not in use, range switch to the OFF position.
- ⇒ If the meter is not used for a long time, batteries should be removed to prevent damage to the meter.

2. Descriptions

2.1 Part Name

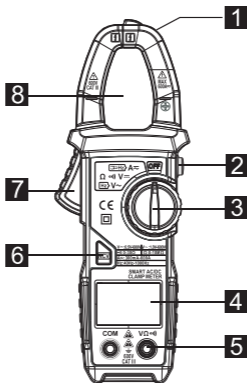

- 1** Non-contact voltage detection sensing area
- 2** Data hold /BackLight button
- 3** Rotary switch
- 4** Display screen
- 5** Input socket
- 6** Non-contact voltage detection button

- 7 Trigger
- 8 Current clamp head: used for measuring current

2.2 Instructions to rotary switch and key as well as input socket

OFF: Meter OFF position



Measuring position





V Ω Ω) COM DC voltage, AC voltage, resistance and buzzer input terminals

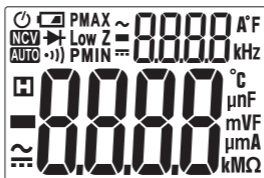

Current input into mutual inductor

2.3 LCD Display Unit



	AC, DC
	Connected disconnect indicate
AUTO	AutoScan Mode
	Automatic shutdown indicate
	LOW BATTERY
	Readings hold status
V,A	Volt (voltage), Ampere (current)
Ω , $k\Omega$, $M\Omega$	Ohm, Kiloohm, Megohm (resistance)
Hz, kHz ,	Hertz, Kilohertz
NCV	Non-contact voltage detection

3. Specifications

The meter should specify one year as a cycle to re-calibrate in the conditions of 18°C ~ 28°C and relative humidity less than 75.

3.1 Overview

- Automatically select measurement function and range.
- Overload protection for the whole measurement range.
- Maximum allowable voltage between the measuring terminal and the Earth: 600V DC or 600V AC
- Work height: maximum 2000m

- Display: LCD
- Maximum display value: 6000 digits.
- Polar indication: automatically indicate, '-' means negative polarity.
- Over range Indication: '0L' or '-0L' .
- Sampling time: about 3 times/s
- Unit display: with function and quantity of electricity unit display
- Automatic Power off time: 10 minutes
- Power supply: 1.5V AAA battery ×2
- Battery low voltage indication: LCD display  symbol.
- Temperature coefficient: <math> < 0.1 \times \text{accuracy degree} / ^\circ\text{C}</math>
- Working temperature: 18°C ~ 28°C
- Storage temperature: -10°C ~ 50°C

3.2 Technical Index

3.2.1 AC Current

Measurement range	Distinguishability	Accuracy degree
60A	0.01A	±(2.5% reading + 8 word)
400A	0.1A	
400A~600A	0.1A	± (3% reading + 10 word)

- Minimum input current: 0.2A AC current
- Maximum input current: 600A AC current
- Frequency range: 45 ~ 65Hz;

3.2.2 DC Current

Measurement range	Distinguishability	Accuracy degree
60A	0.01A	$\pm (3\% \text{ reading} + 10 \text{ word})$
600A	0.1A	

Minimum input current: 0.3A DC current

3.2.3 DC Voltage

Measurement range	Distinguishability	Accuracy degree
6V	0.001V	$\pm(0.5\% \text{ reading} + 3 \text{ word})$
60V	0.01V	
600V	0.1V	

- Minimum input voltage: 0.5V DC
- Maximum input voltage: 600V DC

3.2.4 AC Voltage

Measurement range	Distinguishability	Accuracy degree
6V	0.001V	$\pm(0.8\% \text{ reading} + 5 \text{ word})$
60V	0.01V	
600V	0.1V	

- Minimum input voltage: 1.0V AC
- Maximum input voltage: 600V AC (effective value)
- Frequency range: 45 ~ 65Hz

3.2.5 Frequency

3.2.5.1 Clamp head frequency measurement (Pass A position):

Measurement range	Distinguishability	Accuracy degree
60.0Hz	0.1Hz	±(1.0% reading + 5 word)
1000Hz	1Hz	

-Measurement range: 40Hz ~ 1000Hz

-Input signal range: ≥2A AC current (effective value)

3.2.5.2 Pass V position:

Measurement range	Distinguishability	Accuracy degree
60.0Hz	0.1Hz	±(1.0% reading + 5 word)
1000Hz	1Hz	

- Measurement range: 40Hz ~ 1000Hz

-Input signal range: ≥0.8V AC voltage (effective value)

3.2.6 Resistance

Measurement range	Distinguishability	Accuracy degree
6kΩ	0.001kΩ	± (0.8% reading + 3 word)
60kΩ	0.01kΩ	
600kΩ	0.1kΩ	
6MΩ	0.001MΩ	
10MΩ	0.01MΩ	

- Overload protection: 600V DC or AC (effective value)



3.2.7 Line on-off test

Measurement range	Distinguishability	Functions
•)	1Ω	If the resistance of circuit being measured is less than 50Ω, then the beeper in the meter may sound.



- Overload protection: 600V DC or AC (effective value)

4. Operation Guide

4.1 Readings Hold

During the measuring process, if the readings are required to hold, slightly touch  key, the display value will be locked, slight press  key again to cancel readings hold.

4.2 BackLight

- 1) In the process of measurement, if the ambient light is too dim, causing reading difficulties, press  key for more than 2s, open BackLight and it will automatically off after about 1 minute.
- 2) During the process if press  key for more than 2s, then the BackLight will be turned off.

4.3 Auto Power Off

- 1) If after 10 minutes when the meter is on without any operation, it will go into hibernation and automatically shut down to save power. Before the meter off, there will be one sound of the buzzer to remind every 1 minute.
- 2) Press any key after auto power off to wake the meter

into working status.

- 3) When turn the meter on, hold the " NCV" key at the same time, then the auto power off function is canceled.

4.4 Measurement Preparations

- 1) Turn the transfer switch, turn on the power. If the battery voltage is low (of about $\leq 2.4V$), the LCD will show "  " symbol, then the battery shall be replaced.
- 2) When the meter has not entered into measurement, it will automatically enter into the status of automatic scan, the meter displays as the following diagram shows.

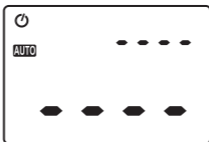

4.5 Non-contact Voltage Detection (NCV)

- 1) Press NCV key for 2s, enable NCV function, the meter displays

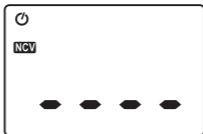

- 2) Press NCV key, put the NCV sensor close to the

measured cable, the meter could detect if the measured cable is $>90\text{V}$ AC voltage or not. When the meter detects AC voltage, the meter buzzer alarms and the backlight flashes.

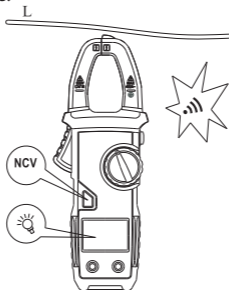

Note:

- 1) Even there is no alarm indication, the voltage might still exist. Do not judge if there exist voltage or not in the cable relying on non-contact voltage detector. The detection operation might be affected by various factors such as the socket design and insulation thickness types are different and so on.
- 2) In NCV detection mode, the meter will not measure the voltage, resistance and current at the same time.

4.6 AC/DC Current Measurement

1) Hold the trigger, open the clamp head and clamp one cable of the measured circuit.

2) When measured signal $>0.2\text{A}$ (AC), the main LCD of the meter displays the measured current value, the vice LCD displays current frequency (Note: only when AC current value $>2\text{A}$ could the meter displays its frequency value)

3) When measured signal $>0.3\text{A}$ (DC), the main LCD of the meter display the measured current value.

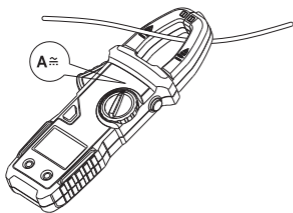

4.7 DC Voltage Measurement

1) Connect the pen-shaped meter to the measured signal, when the measured signal $\geq 0.5\text{V}$, will the meter display current measuring DC voltage value. When measured signal is $<0.5\text{V}$, the meter will be default as resistance value, displays the ohm of the measured signal.

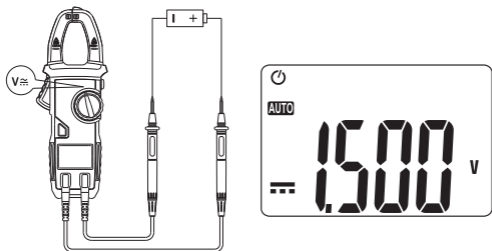

4.8 AC Voltage Measurement

1) Connect the pen-shaped meter to the measured signal, when the measured signal $\geq 1.0V$, will the main LCD of the meter display current measuring AC voltage value, and the vice LCD will display the frequency value of the voltage. When measured signal is $< 1.0V$, the meter will be default as resistance value, displays the ohm of the measured signal.

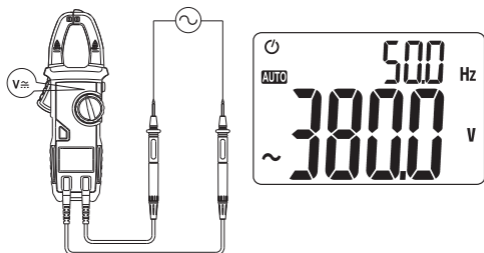

4.9 Resistance Measurement

1) Connect the pen-shaped meter to the measured resistance, when the measured resistance $> 10\text{M}\Omega$, the meter will display----, when the measured resistance is less than 50Ω , the meter buzzer will send out alarm sound.

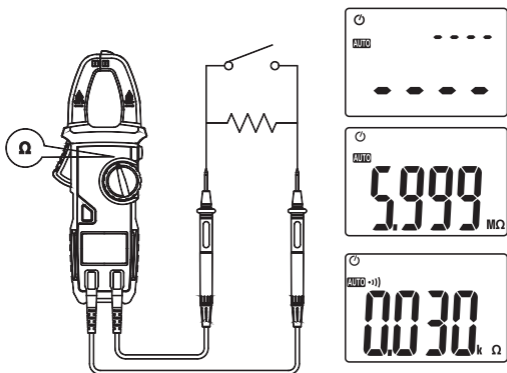

4.10 Measure AC current (or DC current) and AC voltage at the same time

1) Hold the trigger, open the clamp head and clamp one cable of the measured circuit, when the measured signal $>0.2\text{A}$ (AC current 0.2A , DC current 0.3A) , the meter vice LCD will display measured current value.

2) Connect the pen-shaped meter to the measured signal, when the measured signal $\geq 1.0\text{V}$, the meter main LCD will display current measured AC voltage value. When measured signal is $<1.0\text{V}$, the meter will be default as resistance value, displays the ohm of the measured signal.

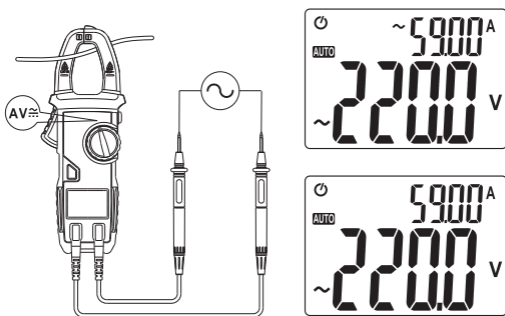

4.11 Measure AC current and DC voltage at the same time

1) Hold the trigger, open the clamp head and clamp one cable of the measured circuit, when the measured signal $>0.2A$ (AC current $0.2A$, DC current $0.3A$) , the meter vice LCD will display measured current value.

2) Connect the pen-shaped meter to the measured signal, when the measured DC signal $\geq 0.5V$, the meter main LCD will display current measured DC voltage value. When the measured DC signal $<0.5V$, the meter will be default as resistance value, displays the ohm of the measured signal.

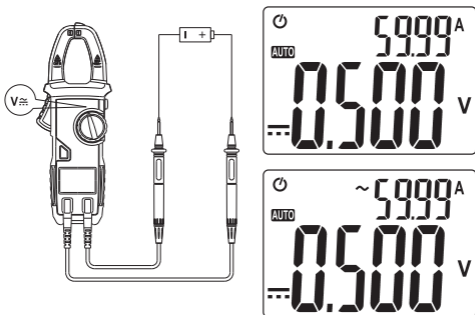

4.12 Measure AC current(or DC current) and resistance at the same time

1) Hold the trigger, open the clamp head and clamp one cable of the measured circuit, when the measured

signal $>0.2A$ (AC current $0.2A$, DC current $0.3A$) , the meter vice LCD will display measured current value.

2) Connect the pen-shaped meter to the measured resistance, when the measured resistance $>10M\Omega$, the meter will display---, when the measured resistance is less than 50Ω , the meter buzzer will send out alarm sound.

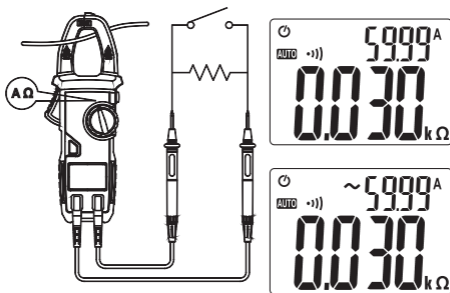

5. Maintenance

5.1 Replace Battery

Warnings



Before opening the battery cover of the meter, the pen-shape meter shall be moved from the measuring circuit first to prevent the risk of electric shock.

- 1 If "  " symbol appears, it means the battery shall be replaced.

- ② Screw the fastening screws of the meter battery cover and move away.
- ③ Replace the old battery.
- ④ Install the battery cover as previous.

Note:

Do not violate the battery polarity.

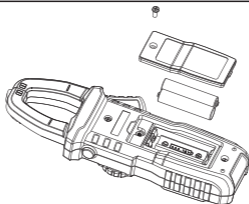

5.2 Replace Pen-shaped Meter

Warnings



When replacing the pen-shaped meter, the new ones shall be of the same or in equal level. The pen-shaped meter shall be in good condition, pen-shaped meter level: 1000V 10A.

If the insulation layer of the pen-shaped meter is damaged, such as the metal wire of the cable is exposed, then it shall be replaced.

6. Accessories

- | | | | |
|---|--------------------|------------------|----------|
| ① | Pen-shaped meter | Level: 1000V 10A | One pair |
| ② | Instruction Manual | | One copy |
| ③ | Battery | 1.5V AAA battery | 2pcs |
| ④ | Cloth bag | | 1pc |